

CAYONOPLAN

- floor-level shower
- classic design with inner contour
- perfect match for the CAYONO model range
- large standing area with central waste at short side
- made of KALDEWEI steel enamel
- IAPMO
- ASME A112.19.1
- CSA B45.2
- ASTM F-462



Illustration shows Model 2251

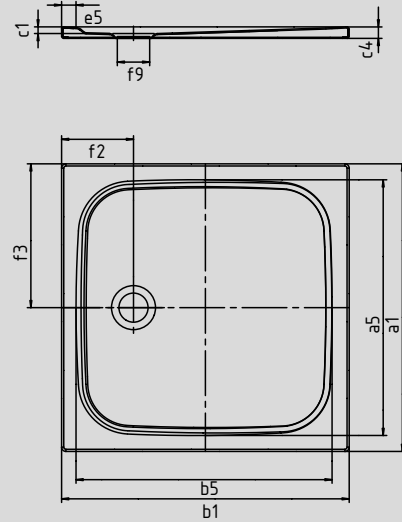
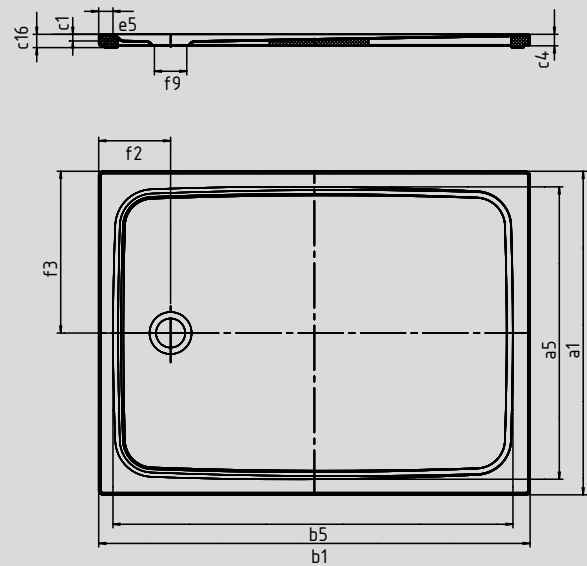

Illustration shows Model 2255 with low profile support



		inch	inch	inch	inch
Model No.		2251	2254	2255	2256
External length	a ₁	31.50	35.43	29.53	31.50
Internal length	a ₅	27.17	31.10	25.20	27.17
External width	b ₁	31.50	35.43	39.37	39.37
Internal width	b ₅	27.17	31.10	35.04	35.04
Internal depth	c ₁	0.71	0.71	0.71	0.71
Height of rim	c ₄	1.26	1.26	1.26	1.26
Height with support	c ₁₆	1.46	1.46	1.46	1.46
Width of rim	e ₅	1.97	1.97	1.97	1.97
Distance bath edge to centre of drain hole	f ₂	7.87	7.87	7.87	7.87
Distance bath edge to centre of drain hole	f ₃	15.75	17.72	14.76	15.75
Diameter of drain hole	f ₉	3.54	3.54	3.54	3.54
Weight of the enamelled shower tray in lbs		0.71	0.87	0.77	0.85