

SANIFORM PLUS

- one-seater bathtub with outlet at foot end
- classic four-cornered model
- made of KALDEWEI steel enamel
- IAPMO
- ASME A112.19.1
- CSA B45.2
- ASTM F-462
- Uniform Plumbing Code (UPC)
- National Plumbing Code (NPC)
- International Plumbing Code (IPC)

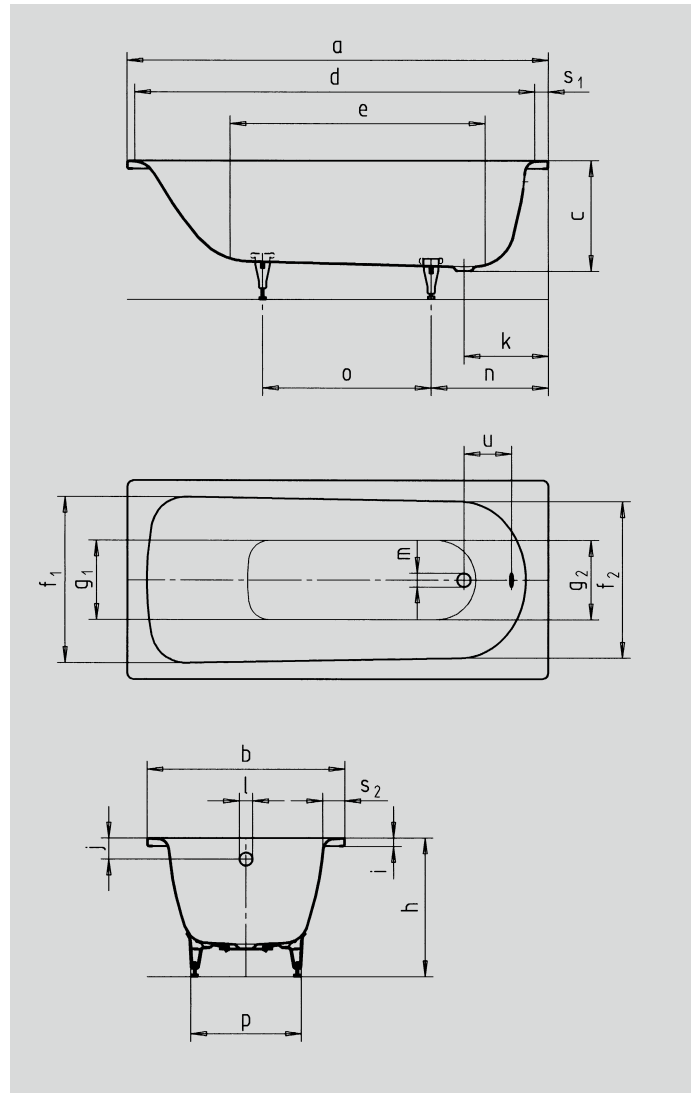

* Feet kit is an optional accessory

		inch	mm	inch	mm	inch	mm	inch	mm	inch	mm
Model No.		360-1	360-1	361-1	361-1	362-1	362-1	363-1	363-1	371-1	371-1
External length	a	55.12	1400	59.06	1500	62.99	1600	66.93	1700	66.93	1700
External width	b	27.56	700	27.56	700	27.56	700	27.56	700	28.74	730
Depth	c	16.14	410	16.14	410	16.14	410	16.14	410	16.14	410
Internal length (top)	d	48.43	1230	52.36	1330	56.30	1430	60.24	1530	60.24	1530
Internal length (bottom)	e	33.46	850	37.40	950	41.34	1050	45.28	1150	45.28	1150
Internal width (top)	f ₁ ; f ₂	21.65; 20.87	550; 530	21.65; 20.87	550; 530	21.65; 20.87	550; 530	21.65; 20.87	550; 530	21.65; 20.87	550; 530
Internal width (bottom)	g ₁ ; g ₂	15.35; 13.78	390; 350	15.35; 13.78	390; 350	15.35; 13.78	390; 350	15.35; 13.78	390; 350	15.35; 13.78	390; 350
Height with feet	h	21.06-21.85	535-555	21.06-21.85	535-555	21.06-21.85	535-555	21.06-21.85	535-555	21.06-21.85	535-555
Height of rim	i	1.26	32	1.26	32	1.26	32	1.26	32	1.26	32
Distance top edge to centre of overflow hole	j	2.48	63	2.48	63	2.48	63	2.48	63	2.48	63
Distance tub edge to centre of drain hole	k	12.20	310	12.60	320	12.20	310	12.20	310	12.20	310
Diameter of overflow hole	l	2.05	52	2.05	52	2.05	52	2.05	52	2.05	52
Diameter of drain hole	m	2.05	52	2.05	52	2.05	52	2.05	52	2.05	52
Distance foot end of tub edge to centre of foot	n	17.91	455	17.52	445	17.72	450	17.72	450	17.72	450
Distance between the feet	o	17.52	445	21.85	555	23.62	600	29.13	740	29.13	740
Max. width of feet	p	14.96	380	14.96	380	14.96	380	14.96	380	14.57	370
Width of rim (foot end; lengthwise)	s ₁ ; s ₂	2.76; 2.95	70; 75	2.76; 2.95	70; 75	2.76; 2.95	70; 75	2.76; 2.95	70; 75	3.35; 3.54	85; 90
Distance between centre holes	u	8.35	212	8.74	222	8.35	212	8.35	212	9.06	232
Water volume** in gallons		17.70		21.66		24.56		29.32		29.32	
Weight of the enamelled bath tub in lbs		88.18		88.18		103.62		105.82		108.03	

Subject to technical alterations and tolerances.
 ** 18.49 gallons displacement on average.

KALDEWEI